

Stützrad Premium

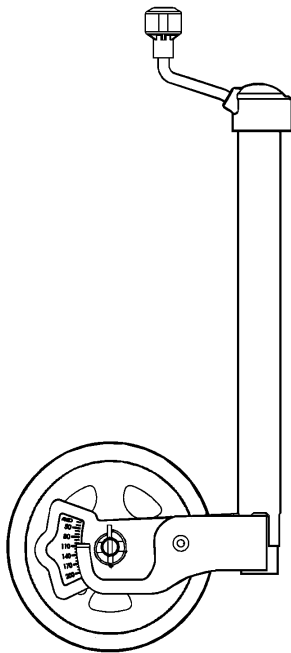

1360350

01/06

- D
- GB
- F
- I
- E
- NL
- DK
- N
- S
- FIN
- CZ
- SK
- H
- PL
- RUS
- SLO
- EST
- LT
- LV
- P
- GR

D **Bedienungsanleitung**
Stützrad Premium

F **Mode d'emploi**
Roue jockey Premium

E **Manual de instrucciones**
Rueda Jockey premium

DK **Brugsanvisning**
Støttehjul Premium

S **Bruksanvisning**
Stödhjul premium

CZ **Návod k obsluze**
Podpěrně kolo Premium

H **Használati utasítás**
utasítás a prémium orkerékhez

RUS **Инструкция по эксплуатации**
Опорное колесо Премиум

EST **Kasutusjuhendi**
Tugiratas Premium

LV **Instrukcijas**
Premium balstritenis

GB **Operating Instructions**
Jockey wheel premium

I **Istruzioni d'uso**
Ruotino d'appoggio premium

NL **Gebruiksaanwijzing**
neus wiel premium

N **Bruksanvisning**
Støttehjul Premium

FIN **Käyttöopas**
Premium-tukipyörä

SK **Návod na používanie**
Podperné koleso Premium

PL **Instrukcja obsługi**
Koło podporowe premium

SLO **Navodila**
Oporno kolo Premium

LT **Instrukcijà**
Atraminis ratas Premium

P **Instruções**
Roda de apoio Premium

GR **Οδηγίες χρήσης συνδέσμου**
Τροχός στήριξης premium

Hersteller · Manufacturer · Fabricant · Produttore · Fabrikant
Hersteller · Fabrikant · Tillverkare · Produsent · Valmistaja
Producent · Vyrобce · Vyrобce · Gyártó · Изготовитель
Gamintojas · Ražotajs · Tootja · Fabricante · τασκευαστής

Alois Kober GmbH, Maschinenfabrik, D-89359 Kötz, Germany
Telefon (08221) 970 Fax 97-390 email: fahrzeugtechnik@al-ko.de

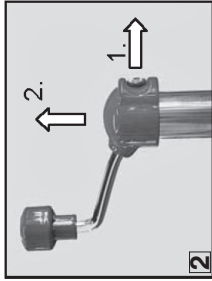
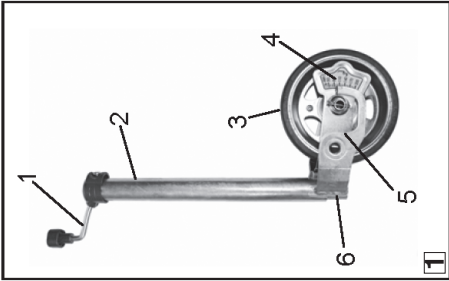
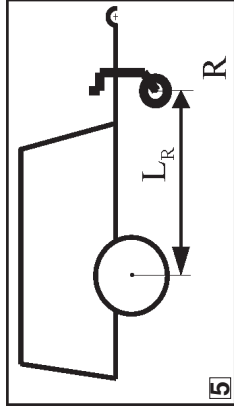
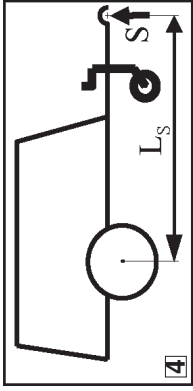
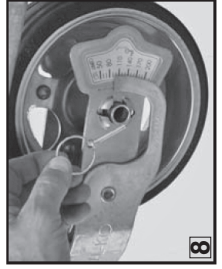
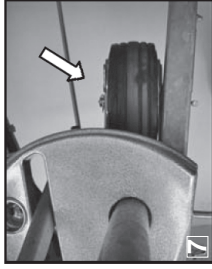
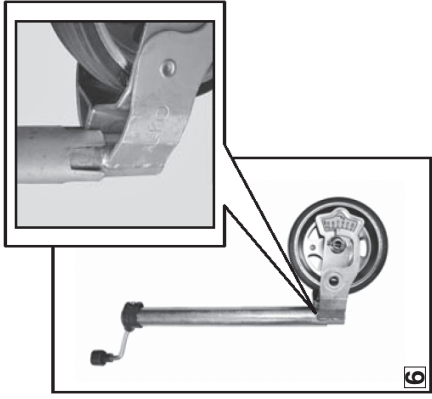

Contents

Manufacturer's Details
Field of application
Safety Information
Assembly
Operation
Spare Parts



Read the operating instructions and act in accordance with them. Keep the operating instructions for general use. Follow the safety instructions, as well as the warning information.



"Caution" denotes work that must be followed exactly to avoid that people sustain injuries or components are damaged.



Special information for better handling for operating, checking and setting procedures as well as maintenance work.

Field of application

The jockey wheel Premium can be used to determine the tongue load on the caravan/trailer indirectly.

Safety Information



Always put the handbrake on



Danger of crushing!
Moving parts

$S_1 = \text{--- kg}$ Max. tongue load of the trailer coupling on the car

$S_2 = \text{--- kg}$ Max. tongue load of the drawbar on the trailer.

$S_3 = \text{--- kg}$ Max. tongue load of the overrun device on the trailer.

$S_4 = \text{--- kg}$ Max. tongue load of the ball-type coupling on the trailer.

$S = \text{--- kg}$ **The smallest of the 4 values is the maximum permissible tongue load (S) for the trailer!**

Step 2: Set the coupling height. Set the coupling height with the aid of the jockey wheel (Fig. 3).

Step 3:

Measure the distance centre wheel to centre ball-type coupling (L_s) (Fig. 4)

$$L_s = \text{--- cm}$$

Step 4: Measure (LR) jockey wheel distance (Fig. 5)

$$L_R = \text{--- cm}$$

Step 5: Calculate jockey wheel display on the jockey wheel (R)

$$R = \frac{\text{---} S \times \text{---} L_s}{\text{---} L_R} \text{--- kg}$$



The carrying wheel must be attached to the forked draw-bar and point in the direction of travel. (Fig. 8)

8. Tighten the collar band T-handle.



Danger of Accident!
Always tighten the collar band T-handle.

9. Sling the contact-breaking cable around the neck of the ball and connect the power cable with the towing vehicle.
10. Check lighting.

Your car and trailer is now ready to drive

Uncoupling the car & trailer

1. Put handbrake on.
2. Unplug contact-breaking cable and power cable from the towing vehicle.
3. Slacken the T-handle from the collar band.
4. Let the jockey wheel down as far as possible.
5. Tighten the collar band T-handle.



Danger of Accident!
Always tighten the collar band T-handle.

6. Turn the crank anti-clockwise until the carrying wheel comes into contact with the ground.
7. Open the ball-type coupling and at the same time continue to turn the crank, until the ball-type coupling lifts off from the trailer device.

Your car and trailer is now ready to shunt.



The carrying wheel must always be next to the forked draw-bar during travel! (Fig. 8)
Handbrake lever rod assembly must move freely!

Jockey wheel Premium (Fig. 1)

1. Crank
2. External tube
3. Carrying wheel
4. Jockey wheel display
5. Support shoe
6. Inner tube

Assembly

Remove the crank (Fig. 2)

1. Pull locking button in the direction of the arrow.
2. Remove the crank.

Fit jockey wheel (Fig. 3)

Fitting to the overrun device

1. Put handbrake on.
2. Lift caravan/trailer up on the overrun device.



Ask a second person to help you or use other aids.

3. Remove the T-handle from the collar band.
4. Remove old jockey wheel.
5. Thread Premium jockey wheel in.
6. Tighten the T-handle on the collar band.

Fit crank

1. Put crank in place until you hear it click in place.
2. Check for tight fit.

Calculate jockey wheel (R) display

Step 1:

Read max. permissible tongue loads from the following rating plates:

Step 5: Note the value determined or mark directly on the scale on the sticker using a waterproof pen.



Read off at eye level so that the value is as accurate as possible.

The marked value can be used as an orientation aid for all further loading processes. You must load your caravan/trailer so that the jockey wheel display shows the value marked (R). The tongue load then moves in the optimum area.



Use the tongue load (S) as fully as possible. This has a positive effect on the road holding.

Operation

Coupling the car & trailer

1. Hunt the ball-type coupling using the tow bar.
2. Open the ball-type coupling and hold if necessary.
3. Turn the crank in a clockwise direction, until the ball-type coupling clicks into place.
4. Continue to turn the crank until the inner tube is completely turned into the grooves.



The support shoe must be fixed in the groove. (Fig. 7)

5. Tighten the crank.
6. Slacken the T-handle from the collar band.
7. Turn the jockey wheel as far upward as possible and attach it to the forked draw-bar.



Handbrake lever rod assembly must move freely!



If you need a greater ground clearance (for driving onto a ferry, sleeping policemen) you can remove the carrying wheel.

Remove carrying wheel (Fig. 9)

1. Pull out linch pin.
2. Pull axle out.
3. Remove wheel.
4. Insert axle again.
5. Insert linch pin.

Spare Parts

Spare parts are safety critical parts! For this reason when fitting spare parts in our products we recommend the use of original AL-KO parts or those parts that we have explicitly approved. The reliability, safety and suitability of parts designed especially for our products, has been determined using a special test procedure. In spite of constantly monitoring the market we are unable to assess or vouch for other products. If repair work or servicing is required AL-KO have a large network of AL-KO service centres throughout Europe. A list of service centres can be requested direct if required. Please bear in mind that repairs should only be carried out by trained and qualified workshops/personnel. To establish the correct spare parts the service centres need the ETI number = spare part identification number.